

INSTRUCTIONS DE MONTAGE

1. BARRE TRANSVERSALE x2
2. ETAGERE LATERAL x2
3. VIS x8
4. NIVEAU x4

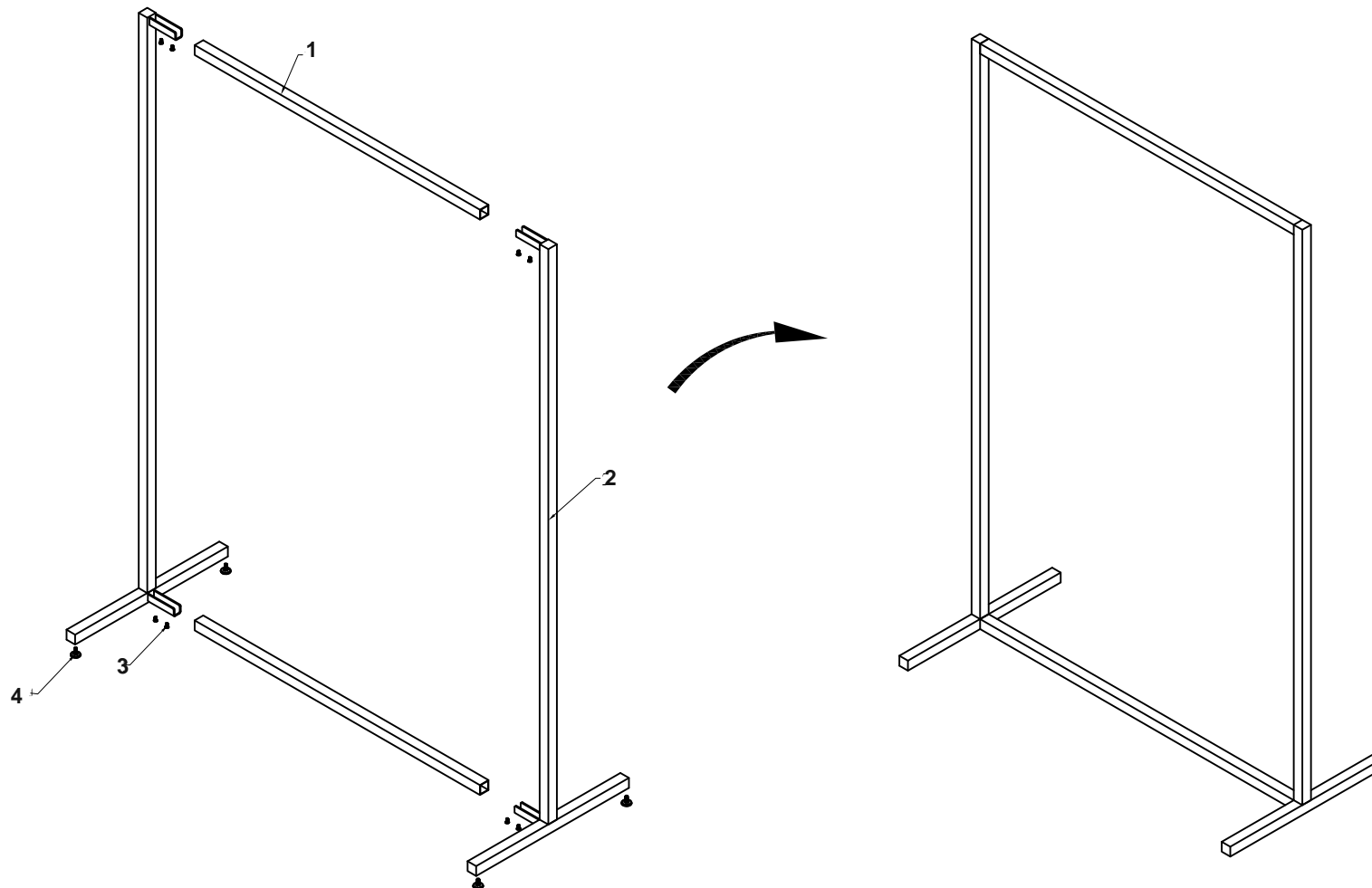

216393

1 SUR 1